

## Operating instructions for Washing machine W 827

It is **essential** to read these operating instructions before installing or using the machine, to avoid the risk of accidents, or damage to the machine.



# Caring for our environment

---

## **Disposal of the packing material**

The transport and protective packing has been selected from materials which are environmentally friendly for disposal and can normally be recycled.

Ensure that any plastic wrappings, bags etc. are disposed safely and kept out of the reach of babies and young children. Danger suffocation!

Rather than just throwing these materials away, please ensure they are offered for recycling.

## **Disposal of your old appliance**

Old appliances contain materials which can be recycled. Please contact your dealer, your local waste collection centre or scrap merchant about potential recycling schemes.

Ensure that the appliance presents no danger to children while being stored for disposal. See the appropriate advice in the "Warning and safety instructions".

## **Caring for our environment**

Disposal of the packing material . . . . .	2
Disposal of your old appliance . . . . .	2

## **Guide to the machine**

Front view . . . . .	6
Control panel . . . . .	7

## **Warning and safety instructions . . . . . 8**

## **Washing environmentally and economically . . . . . 11**

## **Before using for the first time**

Flushing out the machine . . . . .	12
Water hardness reminder dial . . . . .	12

## **How to wash correctly**

Brief guide . . . . .	13
Before washing . . . . .	13
To start a programme . . . . .	14
At the end of a programme . . . . .	16
Adding or removing washing after programme start . . . . .	17
Programme . . . . .	18
. . . interruption . . . . .	18
. . . alteration . . . . .	18
. . . Skipping a programme stage . . . . .	18

## **Adding detergent**

It is important to dispense the correct amount, because . . . . .	19
Adding detergent . . . . .	20
Water softeners . . . . .	20
Fabric conditioners, texturisers, liquid starch . . . . .	20
Automatic fabric conditioners, texturisers, or liquid starch . . . . .	21
Separate fabric conditioner or texturiser . . . . .	21
Starching separately . . . . .	21

# Contents

---

## Programmes

Programme selection . . . . .	22
Sequence . . . . .	24
Care symbols - washing . . . . .	26

## Additional options

Soak . . . . .	28
Pre-wash . . . . .	28
Short . . . . .	28
Water plus . . . . .	29
Spin . . . . .	29
<i>Without final spin.</i> . . . . .	29
<i>Rinse hold.</i> . . . . .	29
Electronic programme locking . . . . .	30

## Programmable functions

Maximum water level . . . . .	31
Water plus system . . . . .	32
Activating the  compartment . . . . .	34
Soak time . . . . .	35
Gentle action . . . . .	36
Top-up rinse for Cottons . . . . .	37
Memory function . . . . .	38

## Cleaning and care

Cleaning the washing machine . . . . .	39
Extra cleaning . . . . .	39
Cleaning the detergent dispenser drawer . . . . .	40
Cleaning the fluff (drain) filter and pump . . . . .	41
To clean the water inlet filters . . . . .	43
To clean the filter in the union in the open end of the inlet hose: . . . . .	43
To clean the filter in the water inlet valve: . . . . .	43

## **Problem solving guide**

The programme does not start. . . . .	44
The wash programme stops and a fault indicator light comes on. . . . .	45
A fault indicator light comes on but the wash programme continues as normal. . . . .	46
General problems or an unsatisfactory wash result . . . . .	47
Opening the drum door in the event of a power failure . . . . .	50

## **After sales service**

Customer contact . . . . .	51
Appliance guarantee . . . . .	51
Future updates (PC). . . . .	51

## **Installation**

Installation surface. . . . .	52
Installation . . . . .	52
Removing the transit fitting . . . . .	52
Re-fitting the transit bars . . . . .	53
Levelling the machine . . . . .	54
Screwing out and adjusting the feet. . . . .	54
Building under a worktop. . . . .	55
Washer and Dryer stack. . . . .	55
Connection to water supply . . . . .	56
Connection to the drainage system. . . . .	57
Electrical connection U.K. . . . .	58

<b>Consumption data</b> . . . . .	60
-----------------------------------	----

<b>Technical Data</b> . . . . .	61
---------------------------------	----

# Guide to the machine

## Front view

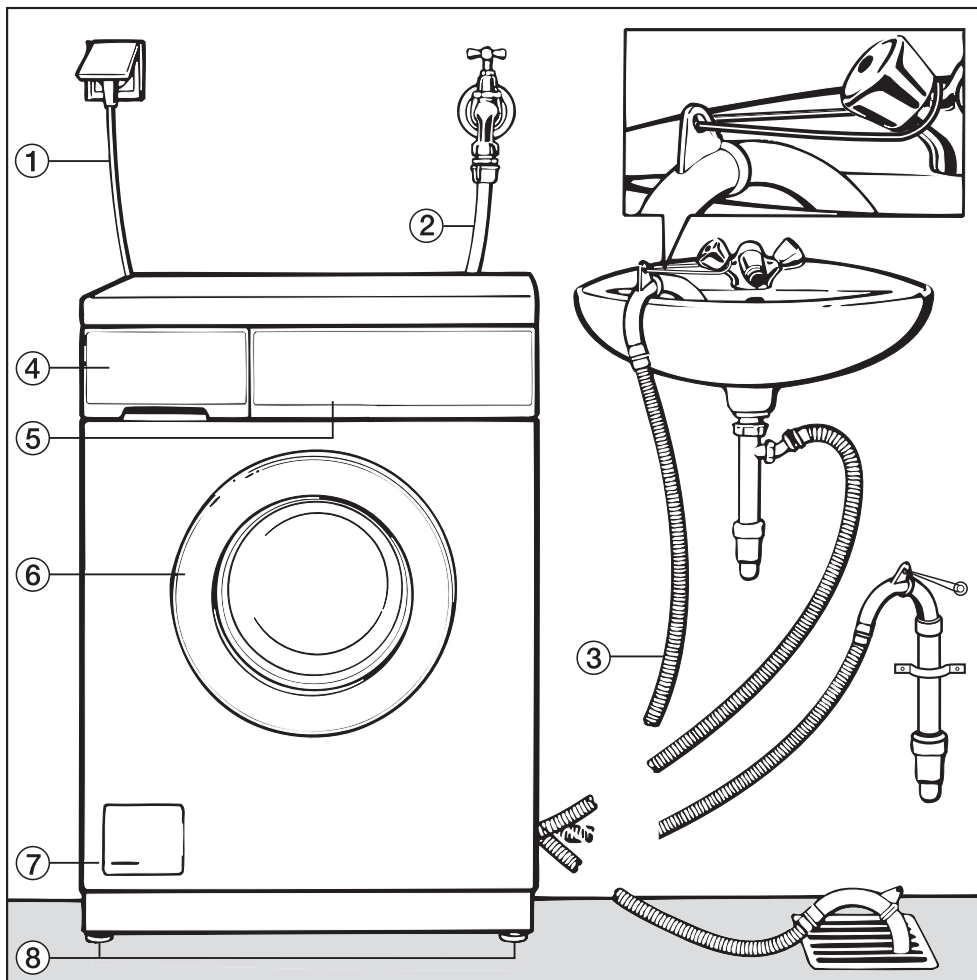

① Electric supply cable

② Inlet hose (able to withstand pressures of at least 70 bar)

③ Flexible drain hose (with detachable swivel elbow)

④ Detergent dispenser drawer

⑤ Facia panel with controls

⑥ Door

⑦ Access panel for drain pump, drain filter and emergency door release

⑧ Four height adjustable feet

## Control panel

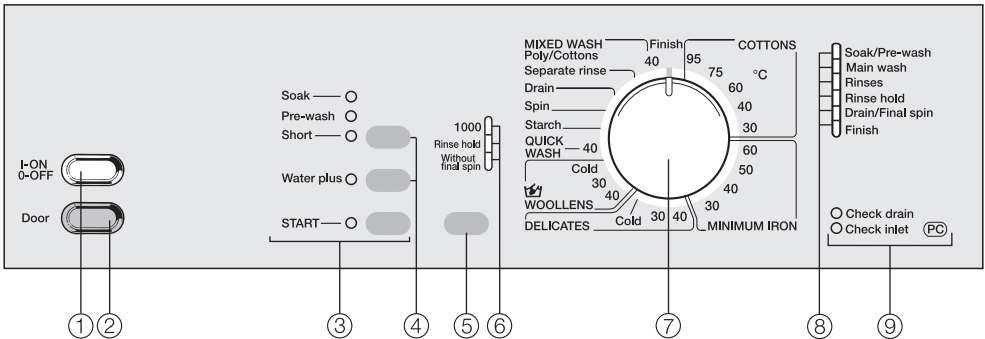

### ① I-ON/OFF button

To switch the machine ON or OFF or to interrupt a programme.

### ② Door button

Opens the machine door.

### ③ START button

Starts the wash programme

### ④ Buttons for additional functions

The upper button is used to select either the *Soak*, *pre-wash* or *Short wash* additional option.

The lower button is used to select the additional option *Water plus*.

### ⑤ "Spin" button

For spin speed, *Rinse hold* and *Without final spin*

### ⑥ Indicator lights

Showing the selected spin speed.

### ⑦ Programme selector

Can be turned clockwise and anti-clockwise.

### ⑧ Programme sequence indicator lights

### ⑨ Check lights

Indicator light on = selected

Indicator light off = not selected

# Warning and safety instructions

---

Read the operating instructions before using this machine for the first time. They contain important information about the safety, use and maintenance of the machine. This way you will avoid the risk of accidents and damage to the machine. Keep these operating instructions in a safe place and ensure that new users are familiar with the content. Pass them on to any future owner of the machine.

## Correct usage

Only use the washing machine to wash items which are specified by the manufacturer to be machine-washable on the wash-care label, and textiles composed of hand-washable wool or wool blend fabrics as well as satin, lace, silk and other hand-washable garments.

Any other applications may be dangerous. The manufacturer is not liable for damage resulting from improper use or operation.

This appliance should not be operated by children. Supervise its use by the elderly or infirm.

## Technical safety

Before setting up the machine, check it for any externally visible damage. Do not install and use a damaged machine.

Before connecting the machine, ensure that the connection data on the data plate (fusing, voltage and frequency) match the mains electricity

supply. If in any doubt, consult a qualified electrician.

The electrical safety of this appliance can only be guaranteed when continuity is complete between the machine and an effective earthing system which complies with local and national regulations. It is most important that this basic safety requirement is regularly tested by a qualified electrician. The manufacturer cannot be held responsible for the consequences of an inadequate earthing system (e.g. electric shock).

Do not connect the appliance to the mains electricity supply by an extension lead. Extension leads do not guarantee the required safety of the appliance (e.g. danger of overheating).

The machine is built in accordance with current safety requirements. Unauthorised repairs could result in unforeseen dangers for the user, for which the manufacturer cannot accept responsibility. Repairs should only be undertaken by a Miele approved engineer.

Ensure current is not supplied to the appliance while maintenance or repair work is being carried out.

The machine is only completely isolated from the electricity supply when:

- it is switched off at the wall socket and the plug is withdrawn, or
- it is switched off at the mains, or
- the mains fuse is withdrawn.



# Warning and safety instructions

---

■ This machine must only be connected to the on-site water supply using a new hose kit. Old hoses must not be re-used. Check the hose regularly for signs of wear and tear. Change in good time to avoid the risk of leaks and subsequent damage.

■ Faulty components must only be exchanged for Miele original spare parts. Only when these parts are fitted can the safety standards of the machine be guaranteed.

■ In countries where there are areas which may be subject to infestation by cockroaches or other vermin, pay particular attention to keeping the appliance and its surroundings in a clean condition at all times. Any damage which may be caused by cockroaches or other vermin will not be covered by the appliance guarantee.

## Use

■ This equipment is not designed for maritime use or for use in mobile installations such as caravans, aircraft etc. However it may be suitable for such usage subject to a risk assessment of the installation being carried out by a suitably qualified engineer.

■ Do not install your washing machine in rooms where temperatures below freezing may occur. Frozen hoses may burst under pressure. The reliability of the electronic control system may be impaired at temperatures below freezing point.

■ Before using the machine for the first time, check that the transit fitting at the rear of the machine has been removed (see section on "Installation"). During spinning, a transit fitting which is still in place may result in damage to both the machine and adjacent furniture or appliances.

■ Turn off the stopcock if the machine is to be left for any length of time (e.g. holiday), especially if there is no floor drain (gully) in the immediate vicinity.

■ Flooding danger.

■ If hooking the drain hose into a wash basin, check that the water can drain off quickly enough to prevent the sink from overflowing. Make sure the drain hose is secure, so that the force of the water flowing out of the hose does not dislodge it. Otherwise this will result in flooding.

■ Take care to ensure that foreign objects (e.g. nails, needles, coins, paper clips, etc.) do not find their way into the machine with the washing (e.g. in pockets). Foreign objects can damage components of the machine, which in turn can result in damage to the washing.

# Warning and safety instructions

---

■ If the correct amount of detergent is dispensed, the machine should not need to be descaled. If, however, you do wish to descale the machine only use proprietary non-corrosive descaling agents and strictly observe the instructions on the packaging. If in doubt, contact the Miele Customer Service Dept. or your Miele Dealer.

■ Textiles which have been pre-treated in solvent based cleaning agents must be thoroughly rinsed in clean water before being washed in the machine.

■ Never use solvent based cleaning agents in this machine, as this may result in damage to component parts and create toxic fumes. Such detergents also pose a fire and explosion hazard.

■ Due to their chemical composition, dyes and colour run and dye removers can cause corrosion. Do not use these products in the machine.

■ For machines with a 'porthole' door, remember that the porthole glass will be hot when washing at very high temperatures. Do not let children touch it.

■ Always make sure the drum is stationary before reaching in to remove washing. Reaching into a moving drum is extremely dangerous.

## Accessories

■ Accessory parts may only be fitted when expressly approved by Miele. If other parts are used, guarantee, performance and product liability claims will be invalidated.

## Disposal of your old machine

■ Before discarding an old machine unplug it. Render the plug useless. Cut off the cable directly behind the appliance to prevent misuse. This should be done by a competent person.

## Washing environmentally and economically

---

- Water consumption and energy usage are determined by the size of the load. Load to the maximum recommended for the programme selected.
- The washing times can vary considerably due to the automatic load adjustment feature. Depending on the amount of the load, the main wash may be shortened and one rinse omitted.
- Use the *Mixed Wash poly/cottons* programme or the *Quick Wash* programme for smaller amounts of laundry.
- To save energy wash normally and lightly soiled laundry at lower temperatures. The 95°C Cottons programme is probably only needed in exceptional circumstances, e.g. for oil based stains or where a very hot wash is required.
- A main wash (programme without pre-wash) is sufficient to clean normally soiled laundry.
- By using the additional option *Soak* for heavily soiled laundry you can select a lower temperature in the main wash.
- Use the additional option *Soak* instead of *Pre-wash* with heavily soiled laundry.  
If *Soak* is followed immediately by a main wash the same suds are used.
- Use the *Short* wash option for normally or very lightly soiled laundry.
- Do not exceed the amounts of detergent which may be recommended by the manufacturer on the packaging.
- Reduce the amounts of detergent with smaller loads, (e.g. with a half load, approx. one third less detergent).
- Select the highest suitable spin speed in the wash programme when tumble drying afterwards.

## Before using for the first time

Before using the machine for the first time ensure that it is correctly installed and connected. See the relevant section under "Installation". Also check that the fluff filter is securely tightened. Otherwise there is a risk of water leakage during use.

### Flushing out the machine

Any residual lubricants and water from testing still in the machine should be flushed out as follows:

- Turn on the stopcock.
- Do not load any laundry.
- Add detergent to compartment **II**, however only add max.  $\frac{1}{4}$  of the amount recommended on the packaging for a full load.
- Press the I-ON/O-OFF button in.
- Turn the programme selector to COTTONS 60°C.

#### Important!

This programme must be selected in order to prepare the machine for spinning and to activate the ball valve.

- Press the *Water plus* button in. The indicator light next to it will come on.
- Press the "Spin" button repeatedly until the *Without final spin* indicator light comes on.
- Press the START button.
- When this programme has finished your washing machine is ready for using for the first time.

### Water hardness reminder dial

Several factors including the water hardness level in your area will affect how much detergent you should use. The small dial in the detergent dispenser drawer can be set purely as a reminder of the hardness level.

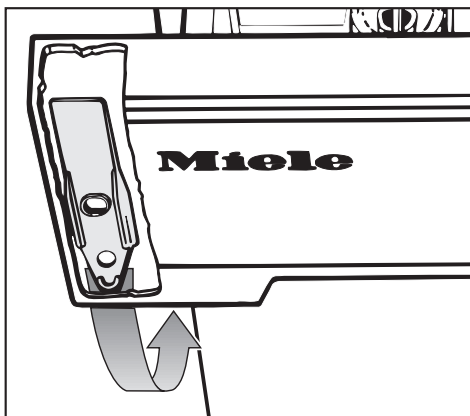

- Remove the yellow spatula from inside the dispenser drawer.

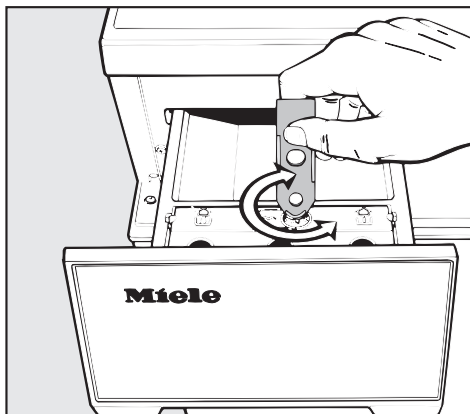

- Adjust the dial to the appropriate setting (1 = soft, 4 = very hard).

## Brief guide

The headings numbered (1, 2, 3,...) show the operating sequence and can be used as a brief guide.

### Before washing

#### 1 Sort the laundry.

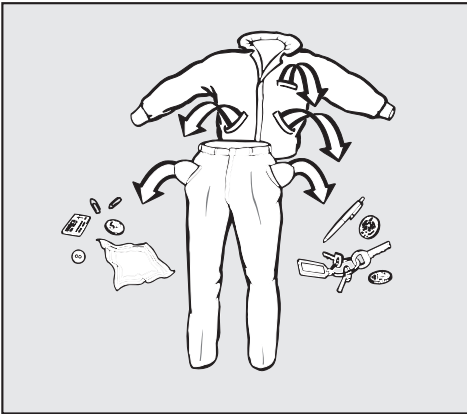

#### ■ Empty all pockets.

Foreign objects (e.g. nails, coins, paper clips, etc.) can cause damage to textiles and components in the machine.

Most garments have a textile care label in the collar or side seam. Sort the washing by care label symbols. (See "Programmes - Care symbols" for their explanation).

Dark textiles often contain excess dye and should be washed separately several times before being included in a mixed load. Always wash whites and coloureds separately.

Delicate textiles should be washed separately in a delicates programme (use a washing bag where appropriate).

Do not wash any items in this machine which are specified by the manufacturer as **non-machine washable** on the care label. (☒ symbol)

### Pre-treat the laundry

Badly soiled areas, e.g. collars and cuffs, and water soluble stains can be pre-treated with bar soap, liquid detergent or detergent mixed into a solution or paste.

With particularly stubborn stains ask your dry cleaner for advice. Do not use solvent-based cleaning agents in this machine.

- Curtains:  
Remove lead weights and strips or place in a laundry bag.
- Underwiring and collar stiffeners:  
Any loose wiring in bras, shirt collar stiffeners, etc. should be removed or sewn in.
- Knitted garments, trousers and jeans, T-shirts and sweat shirts:  
Turn inside out, if recommended by the manufacturer.
- Close any zips, fasten hooks and eyes etc. before washing.
- Fasten duvet covers to prevent smaller items rolling up inside them.

# How to wash correctly

## 2 Press the Door button.

## 3 Load the drum.

Unfold washing and load loosely in the drum. To achieve best results it is advisable to make up mixed loads consisting of both large and small items. This improves the washing effect and helps distribute the load evenly to keep the machine stable and reduce the noise level during spinning.

Overloading reduces the wash result and causes more creasing.

### Maximum load weights are noted below:

COTTONS	.....	5.0 kg
MINIMUM IRON	.....	2.5 kg
DELICATES/SYNTHETICS	.....	1.0 kg
WOOLLENS 	.....	2.0 kg
QUICK WASH	.....	2.5 kg
MIXED WASH (Poly/Cottons)	....	3.0 kg

## 4 Shut the door with a light swing but do not slam it. Do not push on the door to shut it.

Make sure that there is no obstruction between the drum door and seal.

## 5 Open the stopcock.

## 6 Add detergent.

See section on "detergent" for details.

## To start a programme

### 7 Press in the I-ON/0-OFF button.

- The programme selector should be pointing to Finish, the indicator light *Anti crease/Finish* is lit up in the sequence display.

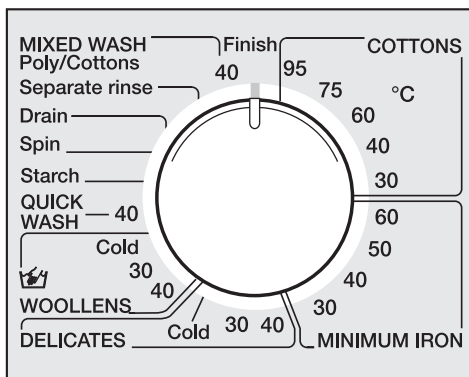

### 8 Turn the programme selector to the programme required

See section "Programmes, Programme survey".

# How to wash correctly

## 9 Select any additional option required.

A maximum of two additional options can be chosen, provided they are compatible with the programme selected, (see the Programme survey in the Section on programmes). Only one option out of "Soak", "Pre-wash" and "Short wash" can be selected.

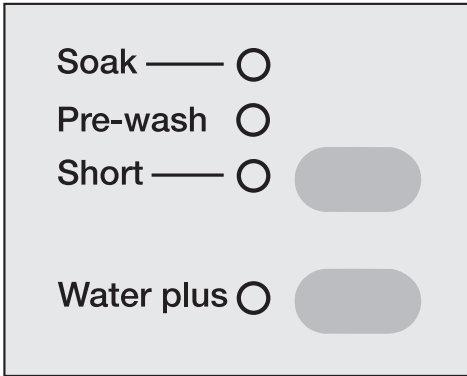

- Press the button for the "Soak", "Pre-wash" or "Short wash" additional options, until the indicator for the chosen option lights up.
- Press the button for the "Water plus" option, if required.

An additional option that has been selected can be de-selected by pressing the button.

## 10 Select spin speed (1000 rpm) or Rinse hold or Without final spin.

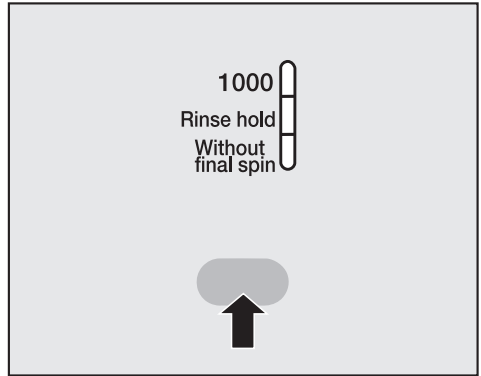

- Press the "Spin" button repeatedly until the indicator light for the required selection lights up.

### Memory-Function

If the last time a programme was run an additional option or different spin speed was selected, the machine will have stored this information in its memory.

The next time that programme is selected the machine offers the additional option and / or spin already stored in memory. (see "Programmable functions")

## 11 Press the "Start" button.

The programme now starts.

# How to wash correctly

---

## At the end of a programme

When the *Finish* indicator light comes on the laundry can be removed from the drum:

- 12 Press the *Door* button.**
- 13 Press and release the I-ON/0-OFF button and turn the programme selector to the *Finish* position.**
- 14 Remove the washing.**

 Only remove washing from the machine once the drum has stopped turning, otherwise you may seriously injure yourself.

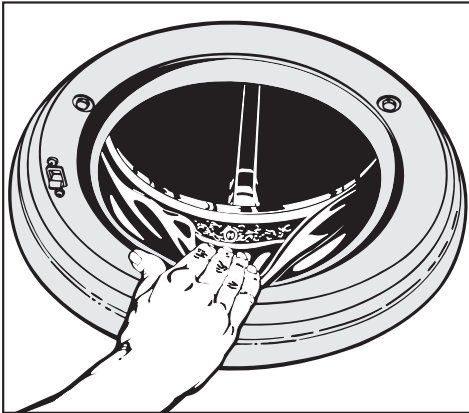

- 15 Check the folds in the door seal for any small articles e.g. buttons which might be lodged there.**

- 16 Close the stopcock.**

- 17 Close the drum door.**

Otherwise there is a danger of objects being placed inadvertently in the drum. If these remained unnoticed and were washed in the next load, they could damage the washing.



## Adding or removing washing after programme start

Washing can be added or removed after the programme has already started, when using the following programmes.

- COTTONS
- MINIMUM IRON
- WOOLLENS 
- QUICK WASH
- Starch
- MIXED WASH

■ Press the *Door* button and hold it until the door springs open.

■ Add or remove items

■ Shut the door.

The programme will automatically continue.

- Apart from some exceptional cases the door can be opened during all sections of COTTONS, WOOLLENS, QUICK WASH, *Starch* and MIXED WASH - *Poly/Cottons* (high cotton percentage) programmes.
- With MINIMUM IRON and MIXED WASH - *Poly/Cottons* (high polyester percentage) the door can be opened during the main wash with some exceptions.

## General exceptions:

The door **cannot be** opened when:

- the suds temperature is above **55°C**.
- the additional option *Water plus* has been selected,
- programme locking is switched on,
- the programme has reached the *Final spin* stage.

# How to wash correctly

---

## Programme . . .

### . . . interruption

- Press the I-ON/O-OFF button.
- To continue with the same programme press the I-ON/O-OFF button again.

### . . . alteration

The machine will accept the following changes after the START button has been pressed,

- selection of a different temperature, extra selection or de-selection of the *Water plus* option can be carried out up to 6 minutes after start.
- the spin speed for final spin can be changed if the programme permits.

After start it is no longer possible to select a different programme.

If a different programme or 6 minutes after start another temperature is selected the indicator light *Anti-crease/Finish* flashes. This does not affect the programme sequence. The indicator light goes out when the programme selector is set back to the programme or temperature previously chosen.

To select a different programme proceed as follows:

- With the I-ON/O-OFF button switch off the appliance.
- Turn the programme selector to *Finish*.
- Switch the machine on with the I-ON/O-OFF button.
- Select a new programme.
- Press the START button.

### . . . Skipping a programme stage

- Turn the programme selector to *Finish*.

As soon as the programme sequence light for the stage at which the programme should continue starts flashing:

- Turn the programme selector switch to the appropriate programme within 4 seconds.

When programme locking has been activated the programme cannot be changed nor can a programme stage be repeated or left out.

All modern detergents produced for automatic washing machines are suitable, including liquid, compact (concentrated), tablets, liquid tablets and special application detergents. Use dispensing aids, e.g. balls, if these are supplied with the detergent. Tablets are suitable for full loads, but note that it may be impractical to reduce tablets by proportion to suit smaller loads.

Woollens and knitwear containing wool mixtures and hand-washable garments should be washed using a detergent specifically designed for washing woollens.

Silk should be washed using a liquid detergent specifically designed for washing woollens. Do not use biological detergents on silk as the enzymes may damage the silk!

Add detergent according to the amount recommended on the packaging. The right amount to dispense will depend on the following:

- The quantity of laundry.
- The soiling level of the laundry.

#### Lightly soiled

No visible dirt or stains. Possibly slight body odour.

#### Normally soiled

Visibly dirty and/or just a few slight stains.

#### Heavily soiled

Stains and soiling clearly visible.

- The water hardness level  
Check with your local water supplier if you do not know the water hardness level.

## Water Hardness

Hardness range	Type of water (hardness)	Hardness level in mmol / l	°dH German
I	soft	0 - 1.3	0 - 7
II	medium	1.3 - 2.5	7 - 14
III	hard	2.5 - 3.8	14 - 21
IV	very hard	over 3.8	over 21

## It is important to dispense the correct amount, because . . .

### . . . too little has the following results:

- Laundry will not be properly clean and will in time become grey and hard to the touch.
- Greasy particles cling to the laundry.
- Limescale deposits on the heater elements.

### . . . too much results in the following:

- Excessive foam.
- Low level of agitation.
- Poor washing, rinsing and spinning results.
- High water consumption (an additional rinse cycle will automatically switch in).
- Burdening the environment.

# Adding detergent

## Adding detergent

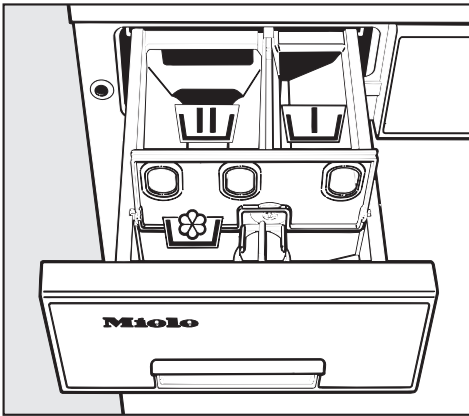





 = Compartment soak/pre-wash. This compartment is also used for starch formulations when starching separately.

 = Compartment main wash

 = Compartment fabric conditioner

Water is taken in through compartment  in the pre-wash.

Water is taken in through compartment  in the main wash. If the capacity of compartment  is insufficient for the amount of detergent needed for a COTTONS programme (e.g. in very hard water areas), the machine can be programmed so that water and detergent can also be taken into the main wash through compartment , see "Programmable functions", "Activating compartment ".

## Water softeners

A water softener such as Calgon can be used to cut down on the use of detergents in extremely hard water areas. Dispense according to the amount specified on the packaging. First add detergent and then the water softener.

Use a quantity of detergent as for soft water.

Miele do not recommend connecting the machine to a household water softener.

If you wash using several components (e.g. special application detergents), we recommend always dispensing the agents into compartment  in the following order:

1. Detergent
2. Water softener
3. Stain remover

This way the agents are distributed more efficiently.

## Fabric conditioners, texturisers, liquid starch

Fabric conditioners make garments soft and fluffy to handle and help prevent static cling when tumble drying.

Texturisers are synthetic starch formulations and give body to items e.g. shirts, tablecloths and bed linen.

Starch gives body to items of washing.

- Dispense according to the amount specified on the packaging.

## Automatic fabric conditioners, texturisers, or liquid starch

- Open the lid of compartment .

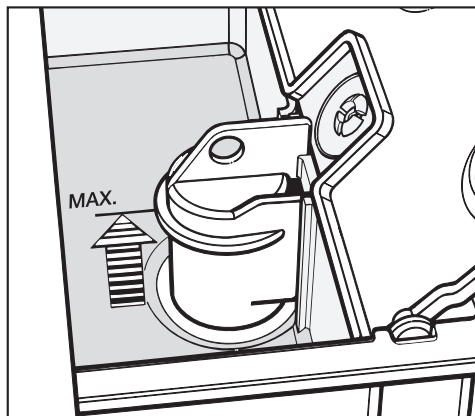

- Add the fabric conditioner, texturiser or liquid starch. **Do not exceed the maximum level mark.**
- Close the compartment lid.
- Push the drawer back in.

The conditioner, texturiser or liquid starch is automatically dispensed in the last rinse. At the end of the programme a small amount of water remains in the fabric conditioner compartment .

If starching frequently, clean the dispenser compartment and especially the siphon tube and conditioner channel. (See section on the detergent dispenser drawer in "Cleaning and Care").

## Separate fabric conditioner or texturiser

- Add fabric conditioner or texturiser to the compartment .
- Turn the programme selector to *Starch*.
- Select a spin speed.
- Press the START button.

## Starching separately

- Measure and prepare starch in accordance with the manufacturer's instructions.
- Add the starch to compartment .
- Turn the programme selector to *Starch*.
- Select a spin speed.
- Press the START button.

# Programmes

## Programme selection

Programme	Fabric	Temperature	max. spin speed
<b>COTTONS</b>	Cottons and linen fabrics, eg bed linen, table linen, towelling, jeans, underwear, T-shirts, nappies.	95°C to 30°C	1000
<b>COTTONS</b>	Wash load as for standard tests	60°C	1000
<b>MINIMUM IRON</b>	(60°C) white nylon, white polyester fabrics (50°C), coloured nylon, polyester, cotton and viscose fabrics with special finishes, acrylic, cotton fabrics, coloured polyester / cotton fabrics, (40°/30°C) minimum iron fabrics not washable at higher temperatures	60°C to 30°C	900
<b>DELICATES</b>	Acrylics, acetate and triacetate, socks and stockings in man-made fibres, (not wool or wool blends)	40°C to cold	600
	Curtains, specified machine-washable by the manufacturer (pre-wash probably advisable).	30°C to cold	600
<b>WOOLLENS</b> 	Programme for machine-washable or hand-washable wool or wool blend fabrics	40°C to cold	1000
	Also suitable for satin, lace, silk and other hand washable garments.*		*
<b>QUICK WASH</b>	Very lightly soiled fabrics, which can be washed in the Cottons programme.	40°C	1000
<b>Starch</b>	Table cloths, napkins, overalls, uniforms.	cold	1000
<b>Spin</b>	Articles which can be spun, eg handwashed items, max weight according to fabric.		1000
<b>Drain</b>			
<b>Separate rinse</b>	Articles which should be washed by hand and only rinsed and spun in the machine.	cold	1000
<b>MIXED WASH Poly/Cottons</b>	Suitable for small loads of garments made from man-made fibres and cotton garments which can be washed together. Sort according to colour.	40°C	900

### cold:

If *Cold* is selected for the temperature, the water is warmed to 24°C. This uniform temperature helps the effect of the detergent.

max. load	Additional options	Notes
5 kg	<ul style="list-style-type: none"> <li>– Soak</li> <li>– Pre-wash</li> <li>– Short</li> <li>– Water plus (Option 1,2,3,4)</li> </ul>	With heavily soiled items select <i>Soak</i> or <i>Pre-wash</i> . Wash dark colours in liquid detergent. For normally soiled items select <i>Short</i> .
5 kg		For test institutes: Programme setting for tests according to EN 60456 Standard Programme
2.5 kg	<ul style="list-style-type: none"> <li>– Soak</li> <li>– Pre-wash</li> <li>– Short</li> <li>– Water plus (Option 1,2,4)</li> </ul>	With heavily soiled items select <i>Soak</i> or <i>Pre-wash</i>  For normally soiled items select <i>Short</i>
1 kg	<ul style="list-style-type: none"> <li>– Soak</li> <li>– Pre-wash</li> <li>– Short</li> </ul>	Use the Wool programme for textiles with wool content
Fill the drum loosely $\frac{1}{2}$ to $\frac{3}{4}$ full	<ul style="list-style-type: none"> <li>– Soak</li> <li>– Pre-wash</li> <li>– Short</li> </ul>	Dust in curtains usually makes pre-wash advisable.
2 kg Do not overload		Use liquid wool detergent.
		Hand washable garments will not shrink, stretch, matt or felt beyond the accepted tolerance. *For satin, lace, silk and other hand washable garments manually select <i>without final spin</i> .
2.5 kg	<ul style="list-style-type: none"> <li>– Water plus (Option 1,2,4)</li> </ul>	Add less detergent (half load)
5 kg		The washing should be washed, but not treated with fabric conditioner.
5 kg		Separate spin is always carried out at 1000 rpm.
5 kg		
3 kg	<ul style="list-style-type: none"> <li>– Soak</li> <li>– Pre-wash</li> <li>– Short</li> <li>– Water plus (Option 1,2,3*,4*)</li> </ul>	The water level, number of rinses and programme time are set automatically in relation to composition of the washing (see "Programmes" Sequence).  *Option is only carried out with a high proportion of cotton.

See Section on Additional options for more details.

### Minimum iron, Delicates, Mixed wash Poly/Cottons:

To spin laundry after a programme with *Rinse hold* press the "Spin" button to select 1000 rpm. The laundry will be spun at the correct lower spin speed. **Do not** turn the programme selector to the separate *Spin* programme.

# Programmes

## Sequence

	COTTONS <sup>1)</sup>	MINIMUM IRON <sup>1)</sup>	DELICATES	WOOLLENS 
Soak	optional	optional	optional	–
Pre-wash	optional	optional	optional	–
Main wash	●	●	●	●
Top-up rinse from 75°C	programmable	–	–	–
Graduated rinsing	–	from 50°C	–	–
No. of rinses				
– normal	3 or 4 <sup>2)</sup>	3	3	2
– part load	2	2	3	2
– short	2	2	3	–
Rinse and interim spin (rpm)	max. 1000	max. 500	–	max. 600
Final spin (rpm)	max. 1000	max. 900	max. 600	max. 1000
Anti-crease, loosen	max. 30 mins	max. 30 mins	max. 30 mins	–
Rinse hold	optional	optional	optional	optional
Without final spin	optional	optional	optional	optional
Wash rhythm	normal	normal	gentle action	Wool
Water level – Wash	low	low	high	medium
– Rinse	low	medium	high	medium

### Explanations:

- Programme section included
- Programme section not included

### 1) Load recognition:

The programme sequence is modified in these programmes according to the absorbency of the load.

### 2) A 4th rinse

automatically switches in if there is too much foam in the drum, or if a spin speed lower than 700 rpm has been selected.

### Wool:

Wool is susceptible to damage from movement when it is wet. The wash action during the course of the programme is low.



Quick Wash	Starch	Spin	Separate rinse	MIXED WASH <sup>1)</sup>	
				high cotton content	high polyester content
–	–	–	–	optional	optional
–	●	–	–	optional	optional
●	–	–	–	●	●
–	–	–	–	–	–
–	–	–	–	–	●
2	–	–	2	3 or 4 <sup>2)</sup>	3
2	–	–	–	2	2
–	–	–	–	2	2
max. 500	–	–	–	max. 900	max. 500
max. 1000	max. 1000	max. 1000	max. 1000	max. 900	max. 900
max. 30 mins	max. 30 mins	max. 30 mins	–	max. 30 mins	max. 30 mins
optional	optional	–	optional	optional	optional
optional	optional	–	optional	optional	optional
normal	normal	–	gentle action	normal	normal
low	low	–	–	low	low
medium	–	–	high	low	medium

### Top-up rinse (programmable):

At the end of the main wash additional water flows into the drum, and the suds are cooled slightly. Hot water might damage plastic drain pipes.

### Graduated rinsing:

The suds are cooled at the end of the wash cycle by water flowing in and being pumped away at intervals thereby minimising crease formation.

### Rinse and interim spin:

There is a spin between the rinses.

### Final spin:





The maximum spin speed according to the programme can be selected with the Spin button. In the programmes MINIMUM IRON, DELICATES, and MIXED WASH, the spin speed is automatically limited to the above stated maximum spin speed.

### Anti-crease, loosen:







The anti-crease action guards against the tendency for creases to set in when fabrics have been left in the drum for a long time. There is drum movement twice a minute.

# Programmes



## Care symbols - washing

<b>Care symbols</b>	<b>Fabric types</b>	<b>Description of process</b>	<b>Programme:</b> (select the appropriate temperature according to the temperature on the care label symbol)
 no bar	Cottons	Normal (maximum) machine action and normal spinning	Cottons, Minimum iron, Quick wash
 single bar	Synthetics	Reduced (medium) machine action and reduced spinning	Delicates  *If the gentle action option has been programmed into your machine via the programmable functions, garments with a single bar under the care label  can also be processed using a Cottons, Minimum Iron, Quick wash, Mixed Wash or Starch programme.
 broken bar	Woollens	Much reduced (minimum) machine action but with normal spinning	Hand Wash Woollens programmes.





## Important - other care symbols

	Hand wash (if a temperature is not specified, use the lowest temperature or cold)
	Do not wash
	Dry clean
	Do not dry clean
	Suitable for chlorine bleaching
	Do not use chlorine bleach





## Tumble dry

	At normal temperature
	At low temperature
	Do not tumble dry

## Ironing

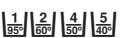
	Hot iron
	Medium hot iron
	Cool iron
	Do not iron

N.B. If you have any textiles with the older wash care labels, select a programme according to the label below:

	Cottons
	Minimum iron
	Delicates
	Woolens

## Additional options

---

To select an additional option to the basic programme press the button for that option. The indicator light for the option comes on.

If an additional option is chosen which is incompatible with the basic programme, (see Programme selection chart), the indicator light goes out when the button is released.

If a spin speed is chosen which is unsuitable for the programme (see Programme selection chart), pressing the button has no effect.

### Soak

For heavily soiled and stained items with protein stains (e.g. blood, fats and oils, cocoa).

- A length of time of between 30 minutes and 2 hours can be chosen, in 30 minute periods, for the *Soak* process.
- The machine is set as standard to two hours soak time.  
See the section "Programmable functions" for reprogramming to a different time.

### Adding detergent for the Soak option:

Add the total amount into compartment **III** or directly on to the laundry in the drum.

### Pre-wash

For heavily soiled and stained items

### Short

This shortens the programme running time. For normally soiled items.

In the COTTONS, MINIMUM IRON and MIXED WASH *Poly/Cottons* programmes only two rinse cycles are carried out with a higher water level.

### Water plus

The water level increases in *soak*, *pre-wash*, *main wash* and / or *rinses*, and / or an extra rinse can be carried out.

You can choose between four options for the *Water plus* button.

The options can be called up through one of the programmable functions, (see *Water plus* system in the Section on programmable functions).

### Switching off the additional options

If an additional option is switched on (and the indicator light in the button is lit up), the option can be switched off by pressing the button. The indicator light goes out.

### Spin

A final spin is carried out at the end of each of the basic programmes, if a spin speed had been selected.

#### ***Without final spin***

Interim rinse and spin is carried out in the relevant programmes.

Washing is not spun after the final rinse, but the water is drained away, and the machine goes straight into the anti-crease stage.

#### ***Rinse hold***

Interim rinse and spin is carried out during the programme cycle.

The washing remains suspended in water after the final rinse.

This helps to reduce the possibility of creasing if the washing is left for some time before being taken out of the machine.

To continue the programme:

Select the required spin speed with the Spin button.

The maximum spin speed is automatically limited according to the basic wash programme chosen, (See Programme Survey section).

# Additional options

---

## Electronic programme locking

Programme locking prevents the machine from being opened or the programme cancelled during a wash programme.

### Switching on programme locking

- Select a programme, (see Brief guide to washing correctly).
- Press the START button for at least 5 seconds.

Programme locking is now activated.

The machine will now not accept any changes, and the wash programme proceeds through to the end.

At the end of the wash programme, the programme locking is discontinued, so that a new wash programme can be chosen.

### Switching off programme locking early

- Press the START button for at least 5 seconds.

Exception:

The indicator light *Anti-crease/Finish* in the Sequence display flashes.

- Turn the programme selector to the programme previously chosen. The *Anti-crease/Finish* light goes out.
- Press the START button for at least 5 seconds.

### To check if programme locking is switched on

- - Press the 'Spin' button.
  - If the spin speed indicator light does not change:

Programme locking is activated.

- If the spin speed indicator light changes:

Programme locking is not activated.

Programmable functions enable the user to introduce further features as required. They remain stored in memory until they are cancelled by the user.

## Maximum water level

The water level for rinsing is automatically raised to the maximum level where rinse results are particularly important.

It is effective for the rinses in the following programmes:

- COTTONS
- MINIMUM IRON
- QUICK WASH
- MIXED WASH - *Poly/Cottons*

Before the "Maximum water level" programmable function can be selected you must first select programming mode.

## Selecting programming mode

- ❶ The machine must be switched off and the drum door closed. The programme selector must point to *Finish*.
- ❷ Press the additional option buttons *Short* and *Water plus* at the same time and hold pressed in and:
- ❸ . . . switch the machine on with the I-ON/0-OFF-button.
- ❹ Let go of all these buttons.

The indicator light *Main wash* flashes in the sequence display.

## Selecting the programmable function

To select the "Maximum water level" programmable function: turn the programme selector to - **MIXED WASH *Poly/Cottons*\*\*\***.

## Activating

To activate "Maximum water level" press the START button once. The *Rinses* light comes on in the sequence display.

## Storing in memory

To store the "Maximum water level" programmable function in the memory SWITCH the machine OFF with the I-ON/0-OFF button.

The "Maximum water level" programmable function is now stored in the machine's memory and is effective in the programmes described above until such time as you may wish to deactivate it.

## Deactivating

To deactivate the use of a maximum water level in the rinses repeat the procedure given above from point ❶ as far as the \*\*\* shown above. Press the START button and the *Rinses* indicator light will go out. The function is now deactivated. Store in memory by pressing the I-ON/0-OFF button.

# Programmable functions

---

## Water plus system

The *Water plus* button offers four options, increasing water level and / or bringing in an extra rinse cycle. To activate the option press the *Water plus* button when selecting your wash programme before pressing the START button.

### Option 1

Increase in the rinse water level in the COTTONS, MINIMUM IRON, QUICK WASH and MIXED WASH - *Poly/Cottons* programmes, where for example rinse results are particularly important.

### Option 2

Increase in the water level in all stages of the COTTONS, MINIMUM IRON, QUICK WASH and MIXED WASH - *Poly/Cottons* programmes. It is particularly suitable for fabrics that need special care, or where extra attention must be given to dissolving detergent. This option is already set when the machine is delivered from the factory.

### Option 3

An extra rinse cycle is introduced to the Cottons programme, e.g. when rinse results are particularly important.

### Option 4

Increase in the water level in all stages of the COTTONS, MINIMUM IRON, QUICK WASH and MIXED WASH - *Poly/Cottons* programmes and adds an extra rinse cycle to the COTTONS

programme, e.g. when rinse results are particularly important.

Before the "Water plus system" programmable function can be selected you must first select programming mode.

## Selecting programming mode

- 1 The machine must be switched off and the drum door closed. The programme selector must point to *Finish*.
- 2 Press the additional option buttons *Short* and *Water plus* at the same time and hold pressed in and:
- 3 . . . switch the machine on with the I-ON/O-OFF-button.
- 4 Let go of all these buttons.

The indicator light *Main wash* flashes in the sequence display.

## Selecting the programmable function

To select the "Water plus system" programmable function turn the programme selector to - **Separate rinse**. The indicator lights in the sequence display correspond to the four options available. As Option 2 has been set at the factory, when the programme selector is turned *Separate rinse*, the indicator light for Option 2 *Rinse hold* will come on.



## Selecting the Options

By pressing the START button you can select the other options. To confirm a new selection another indicator light comes on and the previous one goes out.

Each time START is pressed a different indicator light comes on. The indicator lights correspond to the four options as follows:

Option 1 = *Rinse*

Option 2 = *Rinse hold*

Option 3 = *Drain / Spin*

Option 4 = *Anti crease / Finish*

## Storing in memory

When you have selected the Option you require, SWITCH the machine OFF with the I-ON/O-OFF button. The Option is stored in the machine's memory.

# Programmable functions

---

## Activating the compartment

This function should be activated if traditional "big box" detergents are used. For the first 10 seconds of the Cottons main wash cycle water flows in through compartment .

Compartment  may sometimes not be able to hold the total amount of detergent required when:

- the water is very hard (over 3.8 mmol/l, water hardness level IV) and
- the washing is heavily soiled.

In this case compartment  can be used to flush in the extra detergent for the main wash.

Before the "Activating the  compartment" programmable function can be selected you must first select programming mode.

### Selecting programming mode

- ① The machine must be switched off and the drum door closed. The programme selector must point to *Finish*.
- ② Press the additional option buttons *Short* and *Water plus* at the same time and hold pressed in and:
- ③ . . . switch the machine on with the I-ON/O-OFF-button.
- ④ Let go of all these buttons.

The indicator light *Main wash* flashes in the sequence display.

## Selecting the programmable function

To select the "Activating the  compartment" programmable function turn the programme selector to - **Spin** \*\*\*.

### Activating

To activate "Activating the  compartment" press the START button once. The *Rinses* light comes on in the sequence display.

### Storing in memory

To store the "Activating the  compartment" programmable function in the memory SWITCH the machine OFF with the I-ON/O-OFF button.

The "Activating the  compartment" programmable function is now stored in the machine's memory.

### Deactivating

To deactivate the use of Compartment  repeat the procedure given above from point ① as far as the \*\*\* shown above. Press the START button and the *Rinses* indicator light will go out. The function is deactivated. Store in memory by pressing the I-ON/O-OFF button.

## Soak time

This is accessed for a programme by pressing the SOAK button on the fascia.

You can programme a soak time of:

- 2 hours (factory setting) or
- 1 hour 30 mins or
- 1 hour or
- 30 mins.

A "Soak time" of 2 hours is set at the factory. If you wish to change this standard setting to one of the times listed above, you must first select programming mode.

### Selecting programming mode

- 1 The machine must be switched off and the drum door closed. The programme selector must point to *Finish*.
- 2 Press the additional option buttons *Short* and *Water plus* at the same time and hold pressed in and:
- 3 . . . switch the machine on with the I-ON/O-OFF-button.
- 4 Let go of all these buttons.

The indicator light *Main wash* flashes in the sequence display.

### Selecting the programmable function

To select the "Soak time" programmable function turn the programme selector to - **WOOLLENS Cold**.

The *Rinse* indicator light comes on in the sequence display. This shows that a "Soak time" of 2 hours is currently selected (factory setting).

### Selecting a different "Soak time"

By pressing the START button a various number of times you can select different soak times. To confirm that a different soak time has been selected, the previous indicator light goes out and a new indicator light comes on.

Each time START is pressed a different indicator light will come on. The indicator lights correspond to the 4 soak times available as follows:

2 hours =	<i>Rinse</i>
1 hour 30 mins =	<i>Rinse hold</i>
1 hour =	<i>Drain\Spin</i>
30 mins =	<i>Anti crease\Finish</i>

### Storing in memory

When you have selected the soak time you require, SWITCH the machine OFF with the I-ON/O-OFF button.

The "Soak time" you have selected is now stored in the machine's memory.

# Programmable functions

---

## Gentle action

For gentle washing of slightly soiled items. Drum action is reduced.

Gentle action can be used with the COTTONS, MINIMUM IRON, QUICK WASCH, MIXED WASH - *Poly/Cottons* and *Starch* programmes.

If "Gentle action" has been programmed, every wash cycle in these programmes is carried out with gentle action rhythm.

Before the "Gentle action" programmable function can be selected you must first select programming mode.

### Selecting programming mode

- 1 The machine must be switched off and the drum door closed. The programme selector must point to *Finish*.
- 2 Press the additional option buttons *Short* and *Water plus* at the same time and hold pressed in and:
- 3 . . . switch the machine on with the I-ON/O-OFF-button.
- 4 Let go of all these buttons.

The indicator light *Main wash* flashes in the sequence display.

## Selecting the programmable function

To select the "Gentle action" programmable function turn the programme selector to -

**WOOLLENS 40 °C \*\*\***.

### Activating

To activate "Gentle action" press the START button once.

The *Rinses* light comes on in the sequence display.

### Storing the programmable function in memory

To store the "Gentle action" programmable function in the memory SWITCH the machine OFF with the I-ON/O-OFF button.

The "Gentle action" programmable function is now stored in the machine's memory.

### Deactivating

If the "Gentle action" programmable function is no longer required it can be deactivated. To do so repeat the procedure given above from point 1 as far as the \*\*\* shown above. Press the START button and the *Rinses* indicator light will go out. The function is now deactivated. Store in memory by pressing the I-ON/O-OFF button.

## Top-up rinse for Cottons

At the end of the main wash additional water flows into the drum to cool the suds down.

Hot suds can damage plastic drainage pipes.

Top-up rinse takes place when temperatures of 95°C and 75°C are selected.

Top-up rinse should be activated:

- to prevent the danger of scalding if the drain hose is hooked over the edge of a sink or basin.
- where the drainage pipes do not comply with DIN 1986.

The washing machine is delivered with the "Top-up rinse for Cottons" deactivated.

Before the "Top-up rinse for Cottons" programmable function can be selected you must first select programming mode.

### Selecting programming mode

- 1 The machine must be switched off and the drum door closed. The programme selector must point to *Finish*.
- 2 Press the additional option buttons *Short* and *Water plus* at the same time and hold pressed in and:
- 3 . . . switch the machine on with the I-ON/O-OFF-button.
- 4 Let go of all these buttons.

The indicator light *Main wash* flashes in the sequence display.

## Selecting the programmable function

To select the "Top-up rinse for Cottons" programmable function turn the programme selector to - **DELICATES cold** \*\*\*.

### Activating

To activate "Top-up rinse for Cottons" press the START button once. The *Rinses* light comes on in the sequence display.

### Storing in memory

To store the "Top-up rinse for Cottons" programmable function in the memory SWITCH the machine OFF with the I-ON/O-OFF button.

The "Top-up rinse for Cottons" programmable function is now stored in the machine's memory.

### Deactivating

If the "Top-up rinse for Cottons" programmable function is no longer required it can be deactivated. To do so repeat the procedure given above from point 1 as far as the \*\*\* shown above. Press the START button and the *Rinses* indicator light will go out. The function is now deactivated. Store in memory by pressing the I-ON/O-OFF button.

# Programmable functions

---

## Memory function

If an additional option is selected for a programme, and / or the spin option is altered, the machine stores these changes in memory at the start of a programme.

The memory function is active when the machine is first delivered but can be programmed to be switched off.

### Deactivating

First select programming mode.

### Selecting programming mode

- 1 The machine must be switched off and the drum door closed. The programme selector must point to *Finish*.
- 2 Press the additional option buttons *Short* and *Water plus* at the same time and hold pressed in and:
- 3 . . . switch the machine on with the I-ON/0-OFF-button.
- 4 Let go of all these buttons.

The indicator light *Main wash* flashes in the sequence display.

### Deactivating the programmable function

To de-select the "Memory" programmable function turn the programme selector to

**DELICATES 30°C \*\*\***.

As this programmable function is active when the machine is first delivered, the *Rinses* indicator light will come on in the sequence display as soon as the programme selector is turned to DELICATES 30°C.

To deactivate the "Memory" function press the START button and the light will go out. The memory function is now deactivated.

### Storing in memory

To store this setting in memory SWITCH the machine OFF with the I-ON/0-OFF button.

### Reactivating

To reactivate the memory function repeat the procedure given above from point 1 as far as the \*\*\* shown above. Pressing the START button again will reactivate the "Memory" function and the *Rinses* indicator light will come on again. The function is now reactivated. Store in memory by pressing the I-ON/0-OFF button.

## Cleaning the washing machine

- Clean the casing with a mild non-abrasive detergent or soap and water. Wipe dry with a soft cloth.
- Clean the fascia panel and lid with a damp cloth and dry with a soft cloth.
- The drum can be cleaned using a suitable proprietary stainless steel cleaner.

Do not use abrasive cleaners, glass cleaners or all-purpose cleaners. These might cause damage to the plastic surfaces because of the chemicals they contain.

## E-cloth

A microfibre "E-Cloth" is available from the Miele UK Spare Parts Department, Part Number 98013530, which is suitable for cleaning surfaces such as stainless steel, glass, plastic and chrome without the use of chemicals.

## Extra cleaning

Carrying out a hot wash (70°C or above) with powder detergent approx. once every six weeks will help to ensure that no deposits build up in the machine. These can occur when washing is mainly done at low temperatures, and also lead to unpleasant smells. If you have no reason to wash laundry occasionally at this high temperature, then carry out a 95°C COTTONS programme as a cleaning cycle with powder detergent and no washing, at regular intervals.

## Cleaning and care

### Cleaning the detergent dispenser drawer

- Pull out the detergent dispenser drawer until a resistance is felt.

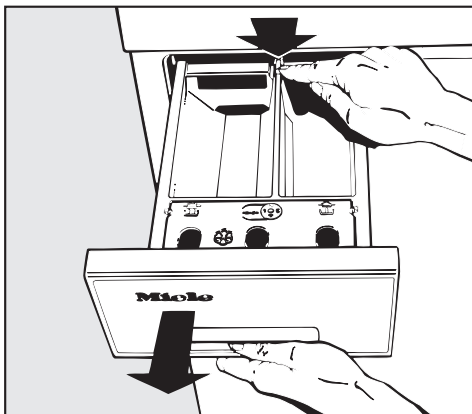

- Press down the red release catch and at the same time pull the drawer right out of the machine.

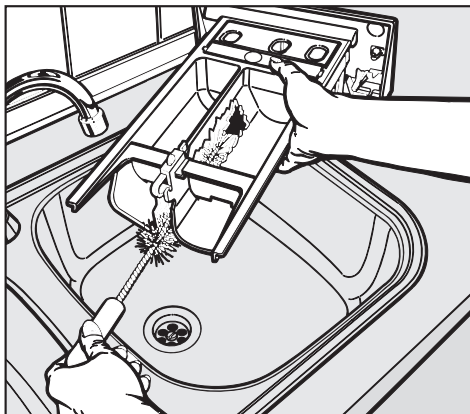

- Clean the dispenser compartments and conditioner channel. Regularly remove any detergent residues.

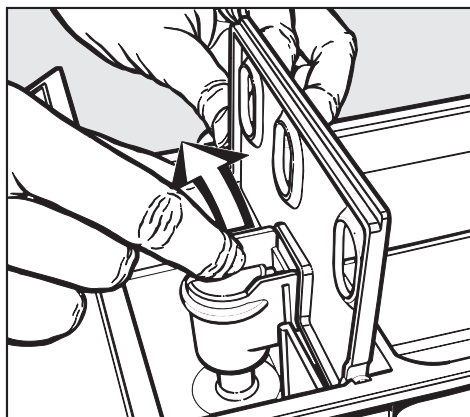

- Remove the siphon tube from compartment . Wash under running warm water and put back.



## Cleaning the fluff (drain) filter and pump

Check the fluff (drain) filter initially after 3-4 washes to ascertain how often it is likely to require cleaning.

With normal cleaning approx. 2 litres of water run out.

If the drain outlet is clogged, more water will be retained in the machine (**up to 25 litres**).

Caution: If laundry has been washed at a high temperature, water draining out of the machine will still be hot.

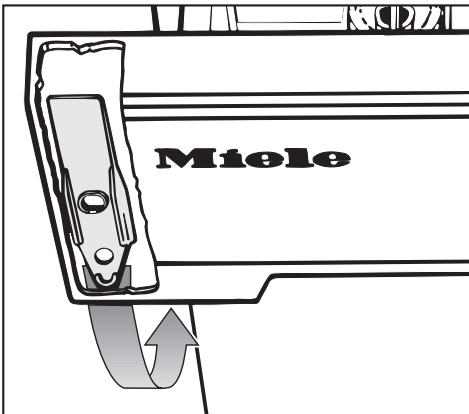

Take the (yellow) filter flap opener from behind the detergent drawer facia panel, (see illustration above).

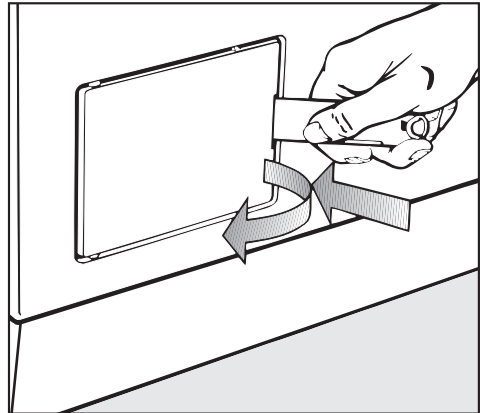

- Open the flap.
- Place a dish under the drain fixture.

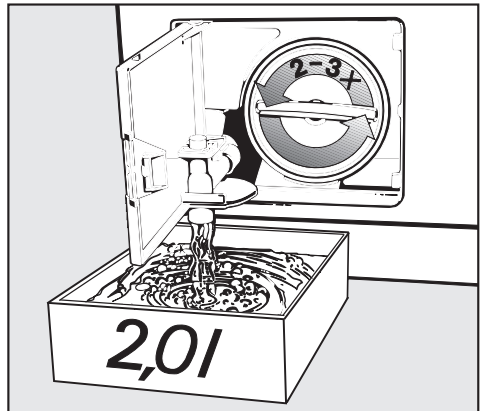

- Turn the fluff filter lid round 2-3 times.  
**Do not** take it right out.

With large volumes of water, when the dish is full screw the fluff filter back into position, and empty the dish before repeating the procedure.

## Cleaning and care

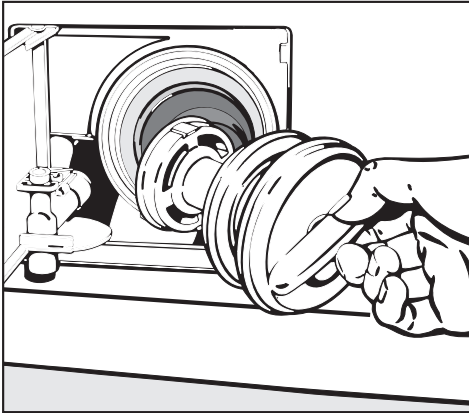

- Once the flow of water ceases, remove the fluff filter completely.
- Clean the fluff filter thoroughly.
- Remove any foreign objects (e.g. buttons, coins, etc.) and fluff.
- Turn the impeller by hand to check that it is free to rotate. Any foreign objects causing an obstruction should be removed.

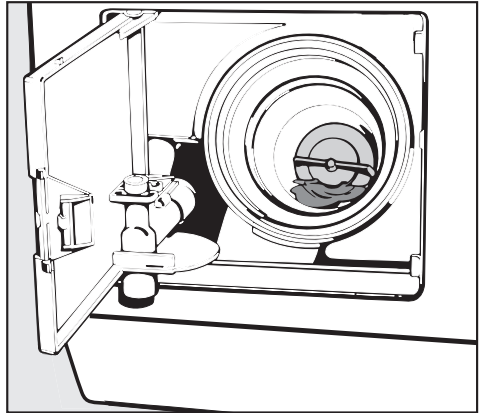

- Clean the inside of the fluff filter housing.

Remove any deposits of limescale and detergent or foreign objects from the thread of the filter housing and filter unit (as these objects can cause a leakage of water). Deposits of limescale are often a sign of underdosage of powder.

- Put the fluff filter back in place and secure it.

Make sure the fluff filter is securely tightened. Otherwise there is a risk of water leakage during use.

### After cleaning

- Pour approx. 2 litres of water into the detergent dispenser compartment  to reactivate the ball valve which keeps detergent in circulation in the suds.

## To clean the water inlet filters

The washing machine has two filters to protect the inlet valves. These filters should be checked every 6 months or so, or more often if there are frequent interruptions to the water supply.

### To clean the filter in the union in the open end of the inlet hose:

- First turn off the stopcock.
- Unscrew the threaded union connecting the free end of the inlet hose to the stopcock.

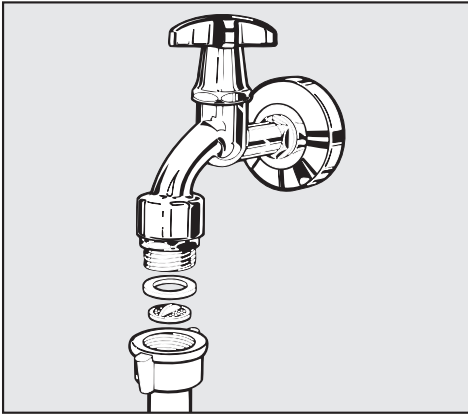

- Remove the rubber seal from the recess.
- Using pointed pliers, take hold of the plastic filter bar, remove the filter and clean.
- Put the filter and seal back in the reverse order and reconnect the hose.

Turn on the stopcock and check the connection is watertight.

Inspect the inlet hose which is subjected to high pressure while the machine is in operation. The hose should be replaced if there are small cracks in the surface, or if it has been otherwise damaged.

If replacing the inlet hose only use a hose able to withstand pressure of at least 70 bar. Miele's own hoses meet this requirement.

### To clean the filter in the water inlet valve:

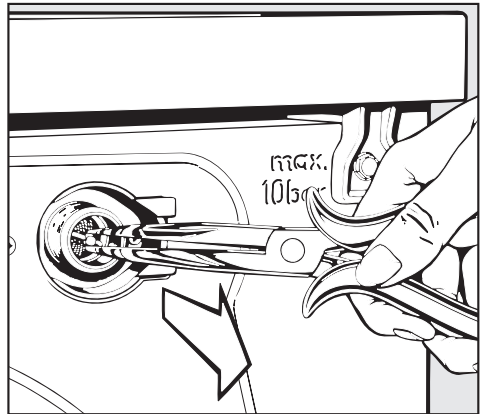

- Using pliers, carefully loosen the ribbed plastic nut on the inlet valve, and unscrew.
- Use water pump pliers to withdraw the plastic filter by the bar (see illustration). Clean, put back and secure.

The two filters **must** be put back in place after cleaning.

## Problem solving guide

With the help of the following notes minor faults in the performance of the appliance, some of which may result from incorrect operation, can be put right without contacting the Service Department.

 Repair work to electrical appliances should only be carried out by a suitably qualified person in accordance with local and national safety regulations. Unauthorised repairs could be dangerous.

### The chart is divided into the following sections to help you:

- The programme does not start.
- The wash programme stops and a fault indicator light comes on.
- A fault indicator light comes on but the wash programme continues as normal.
- General problems or an unsatisfactory wash result.

### The programme does not start.

What to do if ...	Possible cause	Remedy
<b>The <i>Anti-crease/Finish</i> indicator light is not on, or the START indicator light is not flashing.</b>	There is no power.	Check that <ul style="list-style-type: none"><li>– the door is properly closed.</li><li>– the mains plug is plugged in.</li><li>– the fuse or circuit breaker has not tripped.</li></ul>
<b>The programme does not start when <i>Spin</i> has been selected.</b>	The washing machine has not been prepared for using for the first time.	Prepare the machine as described in "Before using for the first time".
<b>At the end of one programme you cannot start the next programme.</b>	The programme selector has not been turned past the <i>Finish</i> position.	Turn the programme selector to the <i>Finish</i> position and then to the programme you want to run.

### The wash programme stops and a fault indicator light comes on.

What to do if ...	Possible cause	Remedy
The <i>Check drain</i> indicator light is flashing.	The water outlet is blocked.	Clean the fluff (drain) filter and drain pump.
	The drain hose has been fixed too high.	The maximum drain height is 1 m.
The <i>Check inlet</i> indicator light is flashing.	The water inlet is blocked	<ul style="list-style-type: none"> <li>– Open the stopcock.</li> <li>– Start the programme again.</li> </ul>
One of the following indicator lights is flashing: <ul style="list-style-type: none"> <li>– <i>Soak/Pre-wash</i></li> <li>– <i>Main wash</i></li> <li>– <i>Rinses</i></li> <li>– <i>Rinse hold</i></li> </ul>	There is a fault.	<ul style="list-style-type: none"> <li>– Press I-ON/0-OFF button to release it.</li> <li>– Turn the programme selector to <i>Finish</i>.</li> <li>– Press I-ON/0-OFF button in.</li> <li>– Re-start the programme.</li> <li>– If the fault indicators occur again, contact the Service Department.</li> </ul>

## Problem solving guide



**A fault indicator light comes on but the wash programme continues as normal.**

<b>What to do if ...</b>	<b>Possible cause</b>	<b>Remedy</b>
<b>The <i>Check drain</i> light flashes.</b>	The drain outlet is restricted.	Clean the fluff (drain) filter and drain pump.
<b>The <i>Check inlet</i> light flashes.</b>	The water inlet is restricted or the water pressure is too low.	<ul style="list-style-type: none"> <li>– make sure the stopcock is opened wide enough.</li> <li>– make sure the inlet hose is not kinked.</li> </ul>
	The filter in the inlet hose is dirty.	Clean the filter.
<b>The <i>Drain/Final spin</i> indicator light flashes in the programme sequence display.</b>	The final spin has not taken place. The machine detected an imbalance.	<ul style="list-style-type: none"> <li>– Loosen and re-distribute the washing.</li> <li>– Select the programme <i>Spin</i> or <i>Drain</i>.</li> <li>– Take into account the spin speed of the relevant programme.</li> </ul>
<b>The <i>Anti-crease/Finish</i> indicator light flashes in the programme sequence display.</b>	The position of the programme selector was altered after the start of the programme. Turn the programme selector back to the programme previously chosen.	

### General problems or an unsatisfactory wash result

What to do if . . .	Possible cause	Remedy
<b>The machine shakes during the spin cycle.</b>	The four feet are not resting evenly on the floor.	Level the machine. See advice on installation.
<b>The laundry has not been spun satisfactorily.</b>	The spin speed selected was too low.	Select a higher spin speed next time.
<b>The drum door cannot be opened by pressing the <i>Door</i> button.</b>	The machine is not connected to the electricity supply.	Put the plug in the socket and switch on.
	Power cut.	Open the drum door as described in the section "Opening the door in the event of a power failure".
	The door was not correctly engaged.	Press hard against the lock side of the drum door and then press the <i>Door</i> button.
	There is still water in the drum and the machine is unable to drain.	Clean the fluff (drain) filter and the drain pump.
	For safety reasons the drum door cannot be opened when the suds temperature is higher than 55°C.	

## Problem solving guide

What to do if ...	Possible cause	Remedy
<b>The pump makes strange noises.</b>	These do not indicate a fault. They occur at the end of a pump sequence as a normal part of the operation.	
<b>Large residues of detergent remain in the dispenser drawer.</b>	The water supply pressure is too low.	<ul style="list-style-type: none"> <li>– Clean the filter in the water inlet system.</li> <li>– It may be useful to press the Water plus button.</li> </ul>
	Washing powder used with water softener tends to become sticky.	Pour washing powder into the dispenser before adding any water softener.
<b>Fabric conditioner is not completely dispensed or too much water remains in the  compartment.</b>	The siphon is either incorrectly positioned or clogged.	Clean the siphon, see "Cleaning and care - Cleaning the detergent drawer".
	The fabric conditioner channel is clogged.	Clean the fabric conditioner channel.
<b>Liquid detergent does not give the required result.</b>	Liquid detergents do not contain bleaching agents. They do not remove fruit, coffee and tea stains.	<ul style="list-style-type: none"> <li>– Use a general purpose washing machine powder containing a bleaching agent.</li> <li>– Pour stain removers into compartment  of the dispenser drawer and liquid detergent into a dispenser ball.</li> <li>– Never put stain removers and liquid detergent together in the dispenser drawer.</li> </ul>



## Problem solving guide

What to do if . . .	Possible cause	Remedy
<b>Grey, greasy particles cling to washed laundry.</b>	Insufficient amounts of detergent were used to break down the particles of grease in heavily soiled laundry.	<ul style="list-style-type: none"><li>– Add more detergent.</li><li>– Before washing the next load run a COTTONS 95°C programme with powder detergent but without a load. (See also "Extra cleaning" in Cleaning and Care).</li></ul>
<b>There are white residues which look like powder detergent on dark coloured laundry.</b>	The detergent contained compounds (zeolites) to aid water softening which are not soluble in water. These have ended up on the laundry.	<ul style="list-style-type: none"><li>– Try and brush off the residues with a soft brush once the laundry is dry.</li><li>– Use a liquid detergent to wash dark coloured textiles. Liquid detergents usually contain no zeolites.</li></ul>

## Problem solving guide

---

### Opening the drum door in the event of a power failure

- Switch off the washing machine.
- Open the fluff (drain) filter flap and drain the water as described in "Cleaning and care", (fluff (drain) filter and pump).

Caution: if laundry has been washed at a high temperature, water draining out of the machine will still be hot.

Always make sure the drum is stationary before reaching in to the machine to remove washing. Reaching into a moving drum is extremely dangerous.

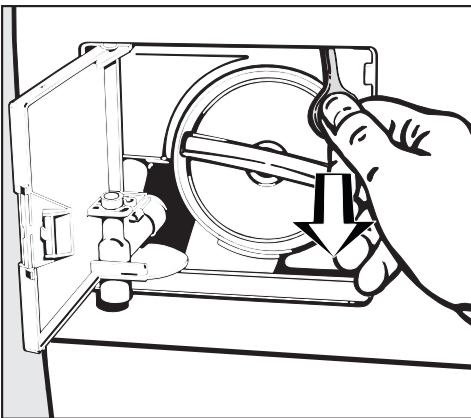

- Pull the emergency door latch downwards (see illustration). The machine door will then open.

### To check water pressure

- Place a bucket under the stopcock.
- Turn on the stopcock.

If 5 litres of water flow into the bucket in 15 seconds the water pressure is correct.

### Customer contact

In the event of any faults which you cannot remedy yourself please contact

- Your Miele Dealer or
- Your nearest Miele Service department (see back cover for the address).

When contacting the Service Department, please quote the Model and Serial nos. of your appliance, both of which are shown on the data plate visible above the porthole glass when the door is opened.

Please note that telephone calls may be monitored and recorded to improve our service.

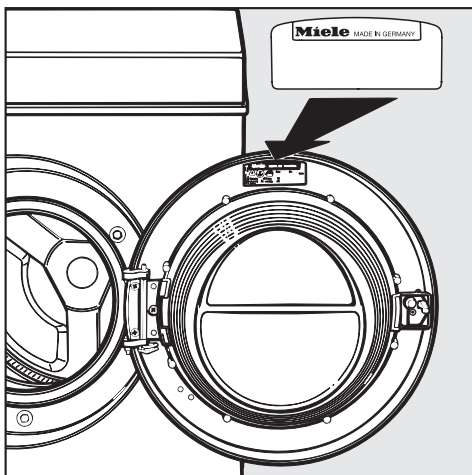

### Appliance guarantee

The appliance is guaranteed for a period of 1 year.

See the guarantee card supplied with the machine for further details.

### Future updates (PC)

The indicator light or check light marked PC is reserved for the service engineer, for updates to your machine in future years.

When for example technological developments offer advanced modifications to your existing programme cycles, a service engineer will be able to input these into your machine controls.

Miele will provide information when such possibilities become available.

# Installation

## Installation surface

A concrete floor is the most suitable installation surface for a washing machine, being far less prone to vibration during the spin cycle than wooden floorboards or a surface with "soft" properties.

Please note the following points:

- The machine must be level and securely positioned.
- To avoid vibrations during spinning, the machine should not be installed on soft floor coverings.
- If installing on a wooden joist floor, we recommend a plywood base at least 30 mm thick, 590 x 520 mm wide. The base should span several joists and be bolted to the joists, not only to the floorboards. Check for the presence of pipes and cables first. The most stable part of the floor is usually in the corner.

 If the machine is installed on a raised plinth, it **has to be** secured against slippage during spin using retaining clips (available from the Miele Spare Parts Dept).

## Installation

Lift the machine from its packaging base and move it to its site. Please note:

- Do not lift the machine by the drum door.
- Ensure that the machine feet and the floor are dry to prevent the machine from slipping during the spin cycle.

## Removing the transit fitting

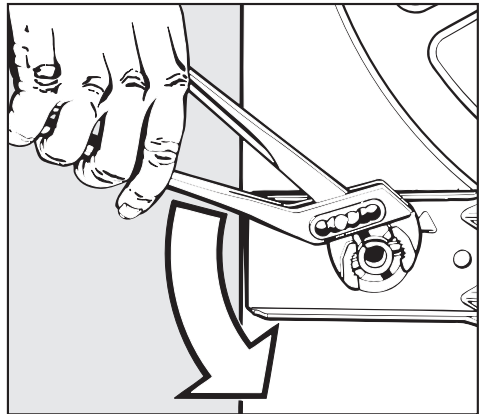

- 1 Turn the left-hand transit bar 90°.

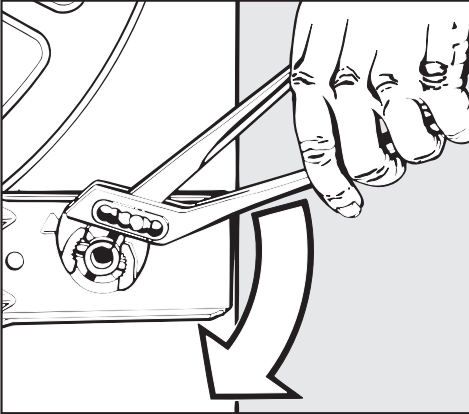

- 2 Turn the right-hand transit bar 90°.

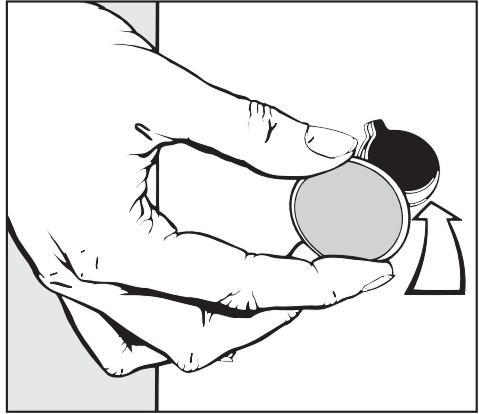

- 4 Plug the two holes with the plastic caps supplied.

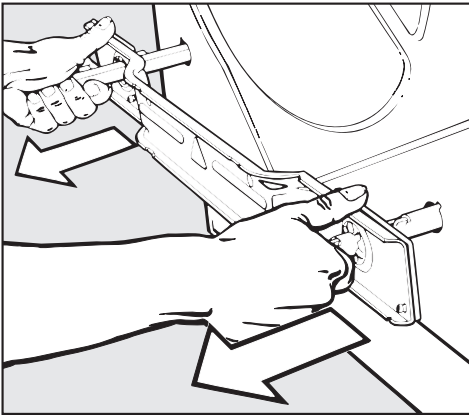

- 3 Withdraw the two bars together with the support plate.

 The washing machine must not be moved without the transit bars in place. Store the transit bars in a safe place for future use. They must be re-fitted if the machine is to be moved again (e.g. when moving house).

## Re-fitting the transit bars

Re-fitting is carried out by reversing the procedure.

# Installation

## Levelling the machine

The machine must stand perfectly level on all four feet to ensure safe and proper operation.

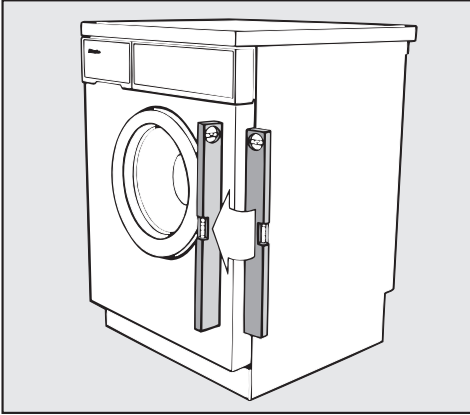

Incorrect installation may increase electricity and water consumption and may cause the machine to move about.

The four adjustable screw feet are used to level the machine. All four feet are screwed in when the machine is delivered.

### Screwing out and adjusting the feet

- Gently tip the machine and prop it up using a solid wooden wedge for example, to ensure stability.

Make sure the machine does not slip as this could cause injury.

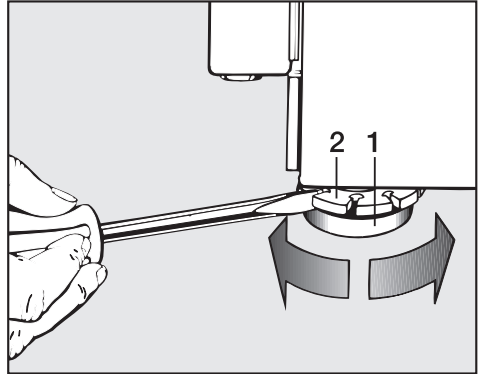

- With a screwdriver loosen and turn the foot **1** together with the counternut **2** to the left, (see illustration below) and screw out.
- Put the machine back on all four feet.
- Use a spirit level to check the machine is standing level.
- Hold the foot **1** firm using a pipe wrench and turn the counternut **2** to the right firmly up against the housing with a screwdriver.

All four counternuts must be firmly up against the housing. Please also check this for the feet which did not need adjustment. Otherwise there is the danger of the machine moving about.

## Building under a worktop

- A special building under conversion kit\* is required which includes a cover plate to replace the machine's lid.
- Fitting instructions are supplied with the conversion kit.

### N.B. Cover plate

The cover plate must be fitted in place of the machine's lid to ensure electrical safety. However, if you wish to push your machine under a worktop and there is space to do this **without removing the lid**, the conversion kit is not necessary. Otherwise the conversion kit is essential.

- For installation under a work surface 900/910 mm from the floor, a raising kit\* is also required.
- To ensure electrical safety the conversion kit and raising kit must be fitted by a suitably qualified installer.
- Connections for electricity, water and drainage should be installed in such a way that they remain accessible when the machine is in place.

## Washer and Dryer stack

A Miele tumble dryer can be stacked with the washing machine. A WTV stacking kit\* is necessary and can be purchased from the Miele Spare Parts Department.

\* All parts marked with a \* are available from the Miele Spare Parts or Sales Department, and must be fitted by a suitably competent person according to the instructions supplied with the kit.

# Installation

---

## Connection to water supply

The machine should be connected to a mains water supply in accordance with standard regulations. In Germany the washing machine is not required to have a non-return valve as it has been designed to comply with the relevant German DIN standard.

Connection to the mains water supply should incorporate a mains stopcock with  $\frac{3}{4}$ " thread. The stopcock should be fitted by a qualified plumber.

The approx. 1.5 m long  $\frac{3}{8}$ " pressure hose should be connected to the stopcock via the  $\frac{3}{4}$ " threaded union.

This pressure hose is **not** suitable for connection to a hot water supply. Please make sure the washer sits correctly in the union.

The connection point is subject to mains water pressure. Turn on the stopcock slowly and check for leaks.

**If replacing the inlet hose only use a hose able to withstand pressure of at least 70 bar. This also applies to all fixtures and fittings used. Miele original parts fulfil this condition.**

Longer hoses 2.5 or 4 metres in length are available as optional extras.

The machine is designed to operate with a water flow pressure of 1 bar minimum up to 10 bar maximum. The static water pressure must not exceed 10 bar. If it is higher than 10 bar it is essential to fit a reducer valve.

There is a minimum flow pressure of 1 bar pressure if 5 litres of water flow into a suitable container in 15 seconds.

The two dirt filters - one in the open end of the inlet hose, one at the inlet point in the solenoid valve must not be removed.



## Connection to the drainage system

The machine drains via a drain pump with a delivery head of 1 metre.

The drain hose is 1.5 m long. It must not be kinked as this restricts drainage. The swivel elbow at the end of the hose can be turned in either direction, or can be detached if required, with a sharp twist and pull.

### Drain hose connection:

1. Direct into a sink or basin:

Please note the following

- Hook the hose over the edge and secure.
  - Make sure that the water can drain away freely without hindrance. Otherwise there is a risk of water overflowing or of some of the drained water being sucked back into the machine.
2. Connected securely to a plastic drain pipe with a rubber nipple. There is no need to use a non-return valve.
  3. Connected securely to a standpipe.
  4. Connected securely to a floor gully.

If required, the drain hose can be extended to a length of 5 m. The necessary parts can be purchased from the Miele Spare Parts Department, or your Miele dealer.

For a delivery head of more than 1 m (up to a maximum of 1.8 m) a second Duo-drain pump is available with the corresponding conversion kit from the Miele Spare Parts Department or your Miele dealer.

# Installation

---

## Electrical connection U.K.

All electrical work should be carried out only by a suitably qualified and competent person, in strict accordance with national and local safety regulations.

The appliance is supplied with a mains cable with moulded plug for connection to a 230-240V mains supply. **The voltage, rated load and fuse rating are given on the data plate.** Please ensure these match the household mains supply.

Connection should be made via a fused plug and suitable switched socket which is easily accessible after installation. For extra safety it is advisable to install a residual current device (RCD), with a trip current of 30 mA (in accordance with DIN VDE 0664, VDE 0100, section 739). Do not connect via an extension lead.

Ensure power is not supplied to the appliance while installation work is being carried out.

### Important

The wires in the mains lead are coloured in accordance with the following code:

Green/yellow = earth

Blue = neutral

Brown = live

Where it is necessary to change plugs, if the colours of the wires in the mains lead of this appliance do not correspond with the coloured markings identifying the terminals of your plug, proceed as follows:

- The wire which is coloured green and yellow must be connected to the terminal in the plug which is marked with the letter E or by the earth symbol  $\perp$  or coloured green, or green and yellow.
- The wire which is coloured blue must be connected to the terminal in the plug which is marked with the letter N or coloured black.
- The wire which is coloured brown must be connected to the terminal in the plug which is marked with the letter L or coloured red.

**WARNING: THIS APPLIANCE  
MUST BE EARTHED**

## **Electrical connection U.K. Non-rewireable plugs BS 1363**

If this machine is fitted with a non-rewireable plug, the following information applies:

If the socket outlets are not suitable for the plug supplied with the product, it must be cut off and an appropriate plug fitted. The fuse carrier and fuse should be removed from the old plug and disposed of.

The plug cut from the flexible cord should then be disposed of and on no account be inserted into any socket elsewhere in the house (electric shock hazard).

The fuse cover must be refitted when changing the fuse, and if the fuse cover is lost, the plug must not be used until a suitable replacement is obtained. The colour of the correct replacement cover is that of the coloured insert in the base of the plug, or the colour that is embossed in words on the base of the plug (as applicable to the design of plug fitted).

Replacement fuses should be ASTA approved to BS 1362 and have the correct rating. Replacement fuse covers may be purchased from your local electrical supplier or Service agent.

# Consumption data

Programme (without any additional options or programmable functions)	Load	Consumption data			
		Energy in kWh	Water litres	Programme time normal      short	
<b>COTTONS</b>					
95°C	5.0 kg	1.70	52	1 h 54 mins	1 h 26 mins
60°C*	5.0 kg	0.95	52	1 h 58 mins	1 h 16 mins
40°C	5.0 kg	0.55	52	1 h 58 mins	1 h 06 mins
<b>MINIMUM IRON</b>					
40°C	2.5 kg	0.45	58	1 h 15 mins	49 mins
<b>DELICATES</b>					
30°C	1.0 kg	0.40	75	58 mins	49 mins
<b>WOOLLENS</b>					
30°C	2.0 kg	0.23	35	35 mins	–

\* EN 60456

Consumption data can vary from the nominal values given depending on water pressure, water hardness, water inlet temperature, room temperature, type and volume of load, fluctuations in the electricity supply and any additional functions selected.

N.B.

Consumption data obtained from a machine designed for the German market.

## Technical Data

Height	85.0 cm
Width	59.5 cm
Depth	60.0 cm
Depth with door open	97.0 cm
Weight	92 kg
Max. floor load	1600 Newton (ca. 160 kg)
Capacity	5 kg Dry laundry
Voltage	see Data plate
Rated load	see Data plate
Fuse rating	see Data plate
Water flow pressure min.	1 bar (100 kPa)
Static water pressure max.	10 bar (1000 kPa)
Drain pump head max.	1.00 m
Drain pump length max.	5.00 m
Test certificates awarded	Radio/TV suppression, VDE







United Kingdom

Miele Co. Ltd., Fairacres, Marcham Road, Abingdon, Oxon, OX14 1TW

tel. Abingdon (01235) 554455 - fax (01235) 554477

Service Office, tel. Abingdon (01235) 554466

Internet: [www.miele.co.uk](http://www.miele.co.uk)